

D.S. Krylov, O.I. Kholod

## Determination of the input filter parameters of the active rectifier with a fixed modulation frequency

**Goal.** Development of a methodology for calculating the parameters of the active rectifier-voltage source input filter operating with a fixed modulation frequency to ensure electromagnetic compatibility with the supply network acceptable by standards at minimum values of the input inductance and checking its main characteristics on a mathematical model. **Methodology.** The authors have developed a methodology for calculating the parameters of the input filter of an active rectifier-voltage source. The calculation results are verified on the constructed mathematical model of a frequency converter, the scheme of which is an active rectifier and an autonomous voltage inverter. A series of experiments was carried out on a mathematical model to study the dependence of the total harmonic distortion of current and mains voltage on the value of the input inductance for various parameters of the input filter. **Results.** The structure and calculation procedure the input filter of an active rectifier operating with a fixed modulation frequency are proposed. The simulation results showed that the inclusion of a filter at the input of the active rectifier significantly improves its electromagnetic compatibility with the supply network in the entire range of variation of the input inductance of the circuit and makes it possible to achieve the values of the total harmonic distortion permissible by the norms. **Originality.** A structure and a calculation procedure the input filter of an active rectifier-voltage source operating with a fixed modulation frequency are proposed. **Practical significance.** The dependencies obtained in the article allow us to evaluate the relationship between the parameters of the filter elements and its characteristics among themselves and come to a compromise between them when designing a scheme for specific technical conditions. References 12, tables 1, figures 13.

**Key words:** input filter, active rectifier, autonomous voltage inverter, output filter, Q factor, pulse-width modulation, total harmonic distortion.

*В статті запропоновано структуру та методику розрахунку вхідного фільтру активного випрямляча-джерела напруги, який працює з фіксованою частотою модуляції. Отримані залежності дозволяють оцінити взаємозв'язок параметрів елементів фільтра та його характеристик між собою та дійти компромісу між ними під час проектування схеми для конкретних технічних умов. Результати моделювання показали, що включення додаткового ланцюга RC фільтра на вході активного випрямляча істотно покращує його електромагнітну сумісність з мережею живлення у всьому діапазоні зміни вхідної індуктивності схеми та дозволяє досягати допустимих нормами значень сумарного коефіцієнту гармонічних спотворень. Бібл. 12, табл. 1, рис. 13.*

**Ключові слова:** вхідний фільтр, активний випрямляч, автономний інвертор напруги, вихідний фільтр, добротність, широтно-імпульсна модуляція, сумарний коефіцієнт гармонічних спотворень.

**Introduction.** Active controlled rectifiers – voltage sources (ARVS) are increasingly being used as input converters of industrial drives of medium power based on autonomous voltage inverters (AVI). They have significant advantages over uncontrolled diode rectifiers: they provide a two-way energy exchange between the motor and the mains; an almost sinusoidal current shape on the side of the supply network with zero or any given shift relative to the phase voltage [1, 2]. The completeness and quality of the implementation of these advantages depends on the selected scheme key management algorithm and the structure of its control system [3, 4]. Here, it is possible to use various concepts that have their own advantages and disadvantages. According to the key control algorithm used, ARVS schemes are with a fixed and variable modulation frequency. This imposes its own peculiarities on the choice of parameters of the elements of the power circuit and the structure of the control system used. In [5, 6], the authors analyzed the operation of the main structures of control systems (CS) of ARVS with a fixed modulation frequency and proposed a new structure of the CS based on the theory of representing instantaneous currents and voltages of a three-phase network in the form of generalized vectors [7, 8]. The analysis showed that a serious problem is high-frequency distortion of the mains current and voltage of the circuit, the value of which depends both on the modulation frequency and on the value of the input inductance of the circuit. To reduce them, it is desirable to use an additional RC circuit in the input filter by analogy with the structure

of the AVI output filter, the definition of parameters and efficiency criteria of which is proposed in [9]. In the literature reviewed by the authors, such a study in relation to the ARVS input filter was not revealed.

**The goal of the work** is to develop a methodology for calculating the parameters of the ARVS input filter operating with a fixed modulation frequency to ensure electromagnetic compatibility with the supply network acceptable by the standards [10] for given values of the input inductance and to check its main indicators on a mathematical model.

**Structural diagram of the converter.** The structural diagram of the medium power frequency drive under consideration based on an autonomous voltage inverter using a three-phase ARVS in the input circuit is shown in Fig. 1.

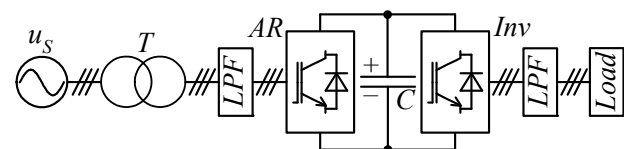

Fig. 1. Structural diagram of the frequency converter with ARVS

It consists of: a three-phase alternating voltage source  $u_s$ ; a converter transformer  $T$ ; ARVS input reactors combined with an LPF filter that suppresses high frequencies; an active rectifier AR made according to the bridge circuit on the keys of alternating current; a capacitor  $C$  in the intermediate DC circuit; a three-phase

© D.S. Krylov, O.I. Kholod

bridge independent voltage inverter *Inv* also made according to the bridge circuit on alternating current switches; an output filter *LPF* suppressing high frequencies; a three-phase symmetrical active-inductive load *Load*.

Having considered the structure of the converter in Fig. 1, it is easy to verify that it is circuit symmetrical with respect to the DC link, namely: a three-phase alternating voltage acts at the input and output of the circuit, and the energy flow can be carried out both from the source to the load and vice versa; ARVS and AVI circuits are made according to the same three-phase bridge circuit on alternating current switches and operate with the same fixed frequency of pulse-width modulation (PWM) for the same installed power of these links. The PWM frequency in this case is determined by the allowable losses in the keys with the cooling system used. Thus, it can be assumed that the influence of both converters on their AC links will be of the same nature and the methods of dealing with its negative factors may be similar.

#### Output filter of an autonomous voltage inverter.

The output voltage of the AVI operating in the PWM mode consists of segments of the DC link voltage connected to the load with a modulation frequency. High-frequency voltage pulses can have different duty cycles depending on the shape of the control voltage generated by the CS. Therefore, the output voltage of AVI with PWM can be represented as the sum of the fundamental harmonic, which changes with the control voltage frequency  $\omega_0$ , and higher harmonics, the highest of which will change with the modulation frequency  $\omega_M$ . All harmonics other than the fundamental are unwanted and must be filtered out.

Figure 2 shows the circuit of the connected between the inverter and the load, which was proposed and discussed in detail in [9].

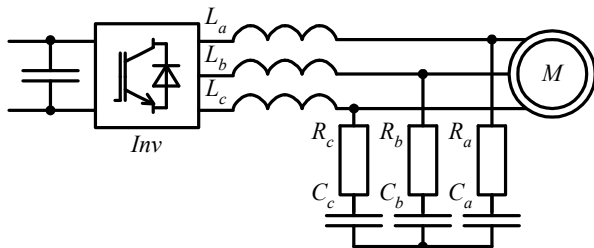

Fig. 2. AVI output filter

It consists of a throttle connected in series with the load, which creates a sufficiently large resistance for the higher harmonics of the phase current, reducing their value at the filter output. However, the load also has an inductance, on which a part of the higher harmonics of the AVI output voltage will be allocated, proportional to the ratio of the load inductance to the total phase inductance. To increase the efficiency of the filter, it is necessary to create a parallel path with low resistance for the current of higher harmonics at its output, which will reduce the voltage drop from their flow at the load terminals. To do this, capacitors are connected in parallel with the load. To reduce the risk of self-oscillations, damping resistors are connected in series with the capacitors. The quality factor

of the resonant circuit of the filter is determined by the expression

$$Q = \frac{\sqrt{L/C}}{R}, \quad (1)$$

and can be taken in the range of 0.5–1 [9] for efficient damping of self-oscillations.

The presence of a resistor reduces the efficiency of the circuit due to energy losses in it. Therefore, the calculation of the filter parameters is aimed at reducing these losses with a sufficient filtering coefficient, which shows how many times the filter attenuates the higher harmonic with the modulation frequency.

It is known from [9] that for the filter in Fig. 2, configured to suppress the higher harmonics of the output voltage of AVI with PWM, there is an optimal filtering coefficient  $K_{fO}$ , which ensures the minimum value of total losses in the filter. It can be defined by the expression

$$K_{fO} = Q \sqrt{\omega_M^* \cdot U_\omega^*}, \quad (2)$$

where  $Q$  is the filter quality factor;  $\omega_M^* = \omega_M / \omega_0$  is the relative modulation frequency;  $U_\omega^* = U_\omega / U_0$  is the relative voltage of higher harmonics at the filter input;  $U_\omega$  and  $U_0$  are the effective values of voltages with PWM frequency and with the main frequency at the filter input, respectively.

Thus, the achievement of the maximum value of the optimal filtration coefficient  $K_{fO}$  when setting the filter parameters will be an indicator of its effectiveness.

When the filter operates with the optimal filtration coefficient  $K_{fO}$ , the relative value of the power losses in it is found as

$$P^* = \frac{P}{S_{base}} = U_\omega^* \sqrt{\frac{2}{K_{fO} \cdot \omega_M^* \cdot K_X}}, \quad (3)$$

where  $S_{base} = U_L \cdot I_L$  is the load phase base full power;  $U_L$  and  $I_L$  are the rated effective values of voltage and current of the load phase, respectively;  $K_X$  is the coefficient that determines the ratio between the reactive power of the throttle and the active power of losses in the filter. It follows from [9] that the value  $K_X$  can be taken in the range of 10–20.

Given the value  $K_X$ , it is possible to determine the relative value of the inductive resistance of the throttle  $X_L^*$  in the form

$$X_L^* = \frac{\omega_0 \cdot L}{Z_{base}} = K_X \cdot P^*, \quad (4)$$

where  $Z_{base} = U_L / I_L$  is the load phase base impedance;  $L$  is the filter throttle inductance.

The relative resistance of the filter resistor is then determined by the formula

$$R^* = \frac{R}{Z_{base}} = \frac{X_L^* \cdot \omega_M^*}{K_{fO}}, \quad (5)$$

and the relative conductivity of the capacitance – as

$$b_C^* = \omega_0 \cdot C \cdot Z_{base} = \frac{X_L^*}{(Q \cdot R^*)^2}, \quad (6)$$

where  $C$  and  $R$  are the capacitance of the capacitor and the active resistance of the filter resistor, respectively.

Thus, given the values  $Q$ ,  $U_{\omega}^*$  and  $K_X$ , from (2)–(6) it is possible to calculate the values of inductance, capacitance, active resistance and power losses in the filter. Here, acceptable power losses in the filter are provided at a relatively high value  $\omega_M^* \geq 40$ , which can be easily implemented on the modern element base of medium power converters [11].

**Input filter of an active controlled rectifier.** The main difference between the ARVS input circuit and the AVI output circuit is that there may not be a filter at the inverter output (its function, to some extent, will be performed by the inductance of the stator winding of the AC machine), and at the ARVS input, the throttle must be present by operating conditions of the scheme. The voltage drop across it, formed as the difference between the voltage of the power source and the voltage at the input of the circuit in the switching interval, forms the required shape and phase of the envelope of the network current of the circuit at the frequency of the supply network. In this case, as in the AVI, the input voltage of the active rectifier consists of segments of the DC link voltage connected to the input of the circuit with a modulation frequency.

It is known [12] that when the ARVS operates with a fixed modulation frequency, the value of its input inductance can lie within wide limits, ensuring the correct operation of the converter. From the point of view of weight, size and cost characteristics of the converter, it is desirable to reduce the value of the input inductance. However, here the qualitative indicators of the operation of the circuit suffer – the frequency distortion of the mains current and supply voltage increases. As well as at the output of the AVI, the input inductance of the ARVS also serves as a filter of higher harmonics generated by the converter into the mains. Its ability to suppress higher harmonics in the mains current and voltage will depend on the ratio of the inductance of the supply network at the point of connection to the total inductance of the phase, taking into account the value of the ARVS input throttle. Since in practice it is often difficult to determine the inductance of the supply network at the connection point of the converter, it is desirable, by analogy with the AVI output filter, to provide a parallel path with low resistance at the converter input for the flow of higher harmonic currents. Thus, the ARVS input filter circuit shown in Fig. 3, in composition and principle of operation, will be completely similar to the output filter circuit and, when ARVS operates with a fixed modulation frequency, the relationships for its calculation will be the same.

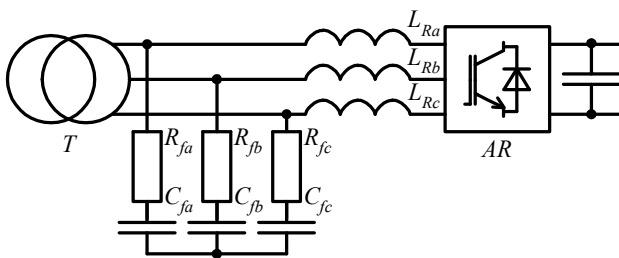

Fig. 3. ARVS input filter

The fundamental difference between the method of calculating the input filter and the one given above is that the value of its inductance is set when calculating the ARVS circuit. We modify the algorithm for calculating the filter of higher harmonics of the active rectifier of Fig. 3 for a known value of its input inductance:

- knowing from the calculation of the ARVS circuit the values of the nominal effective values of the voltage and current of the network phase  $U_S$  and  $I_S$ , the circular frequency of the source voltage  $\omega_S$ , as well as the inductance of the input reactor of the circuit  $L_R$ , by (4) we determine the relative value of the inductive resistance of the throttle  $X_{L_R}^*$  as

$$X_{L_R}^* = \frac{\omega_S \cdot L_R}{Z_{Sbase}}, \quad (7)$$

where  $Z_{Sbase} = U_S / I_S$  is the basic phase impedance;

- given the value  $K_X$  from (4) we obtain an expression for the power losses in the filter

$$P_f = \frac{S_{Sbase} \cdot X_{L_R}^*}{K_X}, \quad (8)$$

where  $S_{Sbase} = U_S I_S$  is the phase base full power;

- jointly solving (2) and (3) we obtain a formula for determining the relative voltage of higher harmonics at the filter input

$$U_{S\omega}^* = \frac{U_{S\omega}}{U_S} = \sqrt[3]{\frac{P_f \cdot Q^2 \cdot K_X^2 \cdot \omega_{SM}^{*3}}{4 \cdot S_{Sbase}}}, \quad (9)$$

where  $\omega_{SM}^* = \omega_{SM} / \omega_S$  is the relative modulation frequency of ARVS;  $U_{S\omega}$  is the effective phase voltage values with PWM frequency at the filter input;  $\omega_{SM}$  is the circular frequency modulation of ARVS.

Here, the quality factor of the input filter circuit  $Q$  is usually taken in the same range of 0.5–1 [9] as that of the output filter.

- using (2), we determine the optimal filtration coefficient  $K_{fSO}$  corresponding to the minimum value of total losses in the filter

$$K_{fSO} = Q \sqrt{\omega_{SM}^* \cdot U_{S\omega}^*}; \quad (10)$$

- the resistance of the filter resistor is determined from (5)

$$R_f = \frac{Z_{Sbase} \cdot X_{L_R}^* \cdot \omega_{SM}^*}{K_{fSO}}, \quad (11)$$

and its capacity – from (6)

$$C_f = \frac{Z_{Sbase} \cdot X_{L_R}^*}{\omega_S \cdot (Q \cdot R_f)^2}. \quad (12)$$

Having previously calculated the basic values  $S_{Sbase}$  and  $Z_{Sbase}$ , using (8), (11) and (12) it is possible to obtain the value of the power losses in the filter  $P_f$ , as well as the values of the active resistance  $R_f$  and capacitance  $C_f$  of the ARVS input filter in absolute units. Their value will depend on the accepted inductance of the filter input reactor  $L_R$  at given values of  $Q$  and  $K_X$ . Let us obtain these dependencies on the example of a specific converter.

The structure of its power circuit corresponds to Fig. 1, and the parameters are taken the same as

in previous studies conducted by the authors on this topic [5, 6, 12]:

- a three-phase alternating voltage source with a short circuit power 150 MVA and a line voltage level of 6 kV;
- a transformer 6 kV/0.4 kV, power 1 MVA;
- a DC link capacity 28 mF;
- ARVS and AVI bridge circuits operate in the sinusoidal PWM mode with a modulation frequency of 4 kHz;
- ARVS operates with a vector control system, and the AVI control system supports the allocation of active power at the level of 315 kW in an equivalent  $RL$  load for any circuit operation mode.

In [12], the required value of the input inductance for such a converter structure was calculated and it was concluded that for the effective operation of the ARVS circuit, its value can be taken in the range of 100–600  $\mu\text{H}$ .

Since the main criterion for calculating the filter is to achieve the maximum value of the optimal filtration coefficient  $K_{fSO}$ , which ensures the minimum value of the total losses in the filter elements, from (8) we construct the dependence of the power losses on the value of the input inductance and coefficient  $K_X$ . In this case, as for the input filter [9], we take the value  $K_X$  in the range of 10–20. The dependence is shown in Fig. 4.

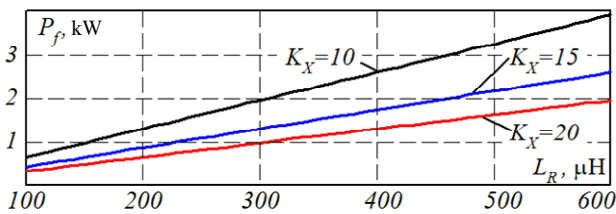

Fig. 4. Dependence of the power losses in the filter on the value of the input inductance

From Fig. 4 it can be seen that with increasing  $K_X$ , the power losses in the filter decrease. Therefore, we construct dependencies for capacitance and active resistance on the value of the input inductance of the filter and the quality factor of its circuit at the maximum accepted value  $K_X = 20$ . They are shown in Fig. 5, 6.

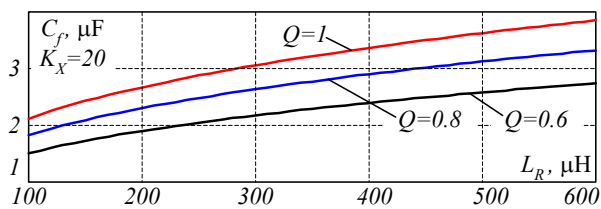

Fig. 5. Dependence of the filter capacitance on the value of the input inductance at  $K_X = 20$

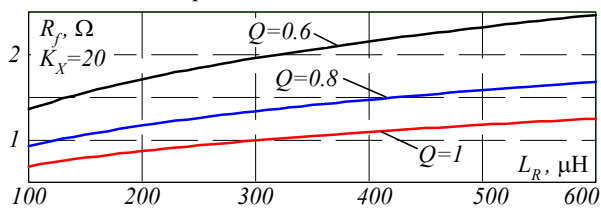

Fig. 6. Dependence of the filter resistance on the value of the input inductance at  $K_X = 20$

Also, according to (10), we obtain the dependence of the optimal filtering coefficient  $K_{fSO}$  on the inductance and quality factor of the resonant circuit of the filter, shown in Fig. 7.

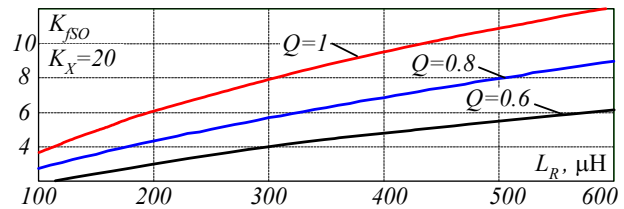

Fig. 7. Dependence of the optimal filtering coefficient on the value of the input inductance at  $K_X = 20$

From Fig. 5–7 it can be seen that an increase in the quality factor of the resonant circuit of the filter leads to an increase in its optimal filtering coefficient  $K_{fSO}$ , as well as to an increase in capacitance and a decrease in the active resistance of the filter with an increase in the input inductance of the ARVS. Within the framework of the calculation algorithm under consideration, according to (8), the power losses in the filter do not directly depend on its quality factor. Based on the above, we can conclude that it is desirable to increase the quality factor of the resonant circuit of the filter. However, this increases the risk of self-oscillations. For completeness of the analysis, we construct the same dependencies for a fixed quality factor  $Q = 0.8$  and various values of  $K_X$ . They are shown in Fig. 8–10.

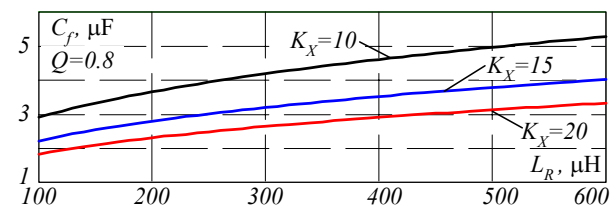

Fig. 8. Dependence of the filter capacitance on the value of the input inductance at  $Q = 0.8$

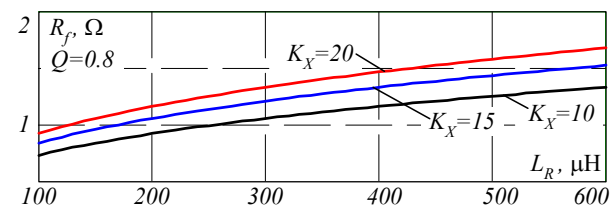

Fig. 9. Dependence of the filter resistance on the value of the input inductance at  $Q = 0.8$

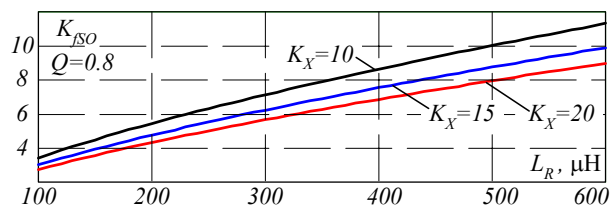

Fig. 10. Dependence of the optimal filtering coefficient on the value of the input inductance at  $Q = 0.8$

Comparing Fig. 7 and Fig. 10 it can be seen that a change in the quality factor of the resonant circuit  $Q$  has a greater effect on the value of the optimal filtering coefficient  $K_{fSO}$  of the filter than a change in the coefficient  $K_X$ . Here, an increase in  $K_X$  leads not only to a decrease in the power losses in the filter, but also to a decrease in its capacitance with the same input inductance. Therefore, when designing the ARVS input filter, it can be recommended to take the maximum values

of  $K_X$  and  $Q$  to increase its efficiency. Let's check it on the mathematical model of the converter.

**Modelling the operation of the circuit.** The modelling of the studied converter system was performed in the MATLAB/Simulink software package. The

external view of the power circuit of the model is shown in Fig. 11. It fully corresponds to the structure shown in Fig. 1 and has the set parameters of the source, load, converters and control systems described above, when obtaining theoretical dependencies.

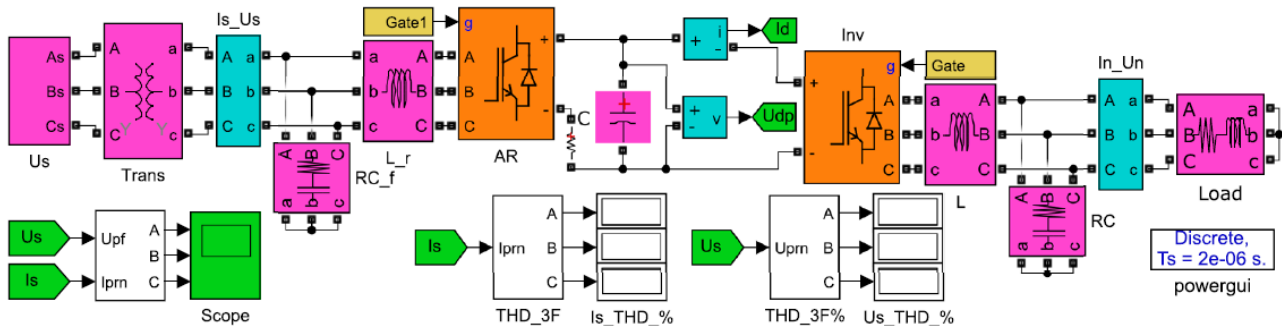

Fig. 11. MATLAB model of the ARVS power circuit

It is known [5] that the voltage at the terminals of the ARVS network phase  $u_V$  is determined by the difference between the phase voltage of the power source  $u$  and the voltage drop at the input throttle from the phase current  $i_S$  flowing through it. That is, at any time

$$u_V = u_S - u_{L_R} = u_S - L_R \cdot \frac{di_S}{dt}. \quad (13)$$

Figure 12 shows the machinodiagrams obtained in the model by (13) for the operation of the ARVS without an additional  $RC$  circuit of the low-pass filter. It can be seen from them that the instantaneous voltage  $u_V$  at the terminals of the phase of ARVS operating with a fixed modulation frequency, is formed similarly to the voltage at the output of the AVI with PWM. Here, the relative position of the mains current, as well as of the first harmonics of the ARVS input voltage  $u_{V(1)}$  and the throttle voltage  $u_{L(1)}$  relative to the sinusoid of the mains voltage  $u_S$ , indicate the correct operation of the circuit in the full reactive power compensation mode.

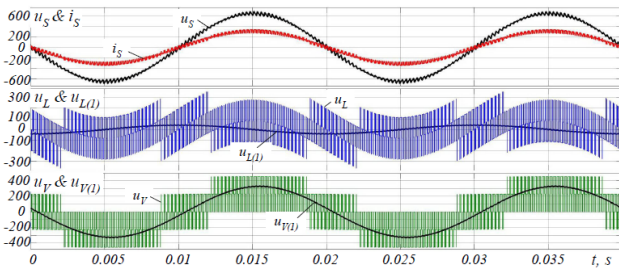

Fig. 12. Machinograms of the circuit operation

With the help of the model in Fig. 11, the dependencies of the total harmonic distortion factor of current ( $THD_I$ ) and voltage ( $THD_U$ ) of the phase at the input of the converter on the inductance of the ARVS input reactor were obtained. The studies were carried out for the case of the absence of an additional  $RC$  low-pass filter circuit in the ARVS input circuit, as well as for the use of a full-fledged input filter according to the structure of Fig. 3, tuned according to the proposed method for the coefficient  $K_X = 20$  at two values of the quality factor of the resonant circuit:  $Q = 0.6$  and  $Q = 1$ . The results are given in Table 1.

According to Table 1 the graphic dependencies of  $THD_I$  and  $THD_U$  at the converter connection point on the

value of the input inductance are plotted, which are shown in Fig. 13. Also in Fig. 13 the dotted line shows the values of  $THD_I$  and  $THD_U$  allowed by the norms [10], which are 5 % and 8 %, respectively.

Table 1

Experimental data of the study						
$THD, \%$	Filter reactor inductance, $\mu\text{H}$					
	100	200	300	400	500	600
Without $RC$ filter						
$THD_I$	7.43	4.14	2.91	2.25	1.85	1.60
$THD_U$	18.07	10.26	7.14	5.45	4.39	3.65
$Q = 0.6, K_X = 20$						
$THD_I$	7.27	3.99	2.74	2.12	1.73	1.49
$THD_U$	14.2	7.75	5.43	4.21	3.44	2.91
$Q = 1.0, K_X = 20$						
$THD_I$	6.63	3.49	2.41	1.87	1.55	1.35
$THD_U$	11.74	6.35	4.46	3.47	2.86	2.44

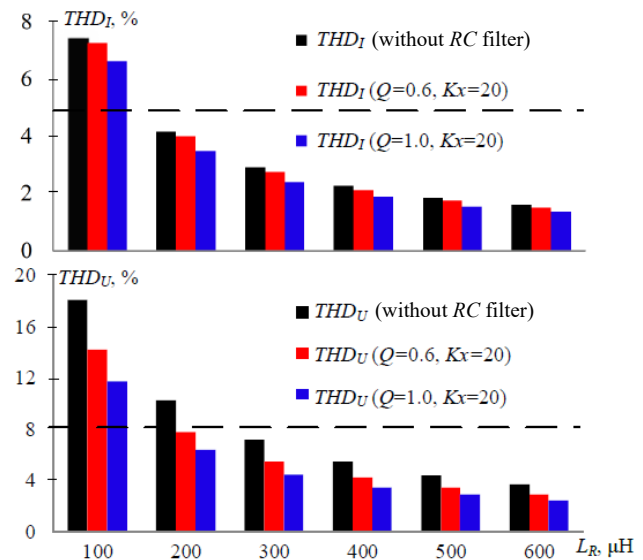

Fig. 13. Graphical dependencies of  $THD_I$  and  $THD_U$

### Conclusions.

1. A new technique is proposed for calculating the parameters of the input filter of an active rectifier – a voltage source operating with a fixed modulation frequency. It is based on the identity of the effect of ARVS and AVI, which are part of the overall structure of the frequency electric drive, on their AC links.

2. In the paper, the authors obtained calculation relationships for determining the values of the active resistance and capacitance of the input filter, as well as the value of the power losses in it in absolute units, depending on the given value of the input inductance of the ARVS. Relationships are constructed that allow estimating the interrelation between the parameters of the filter elements and its characteristics and reaching a compromise between them when designing a circuit for specific technical conditions.

3. Mathematical modelling in an object-oriented software environment has shown that the inclusion of an additional RC circuit of the input low-pass filter significantly improves the electromagnetic compatibility of the ARVS with the supply network in the entire studied range of the input inductance of the circuit, allowing already in the first third of it to reach the allowable values of the total harmonic distortion factor of current and voltage of the source.

**Conflict of interest.** The authors declare no conflict of interest.

#### REFERENCES

1. Bie Y., Li Y., He G., Zhang X. PWM rectifier impedance modelling and analysis. *IOP Conference Series: Earth and Environmental Science*, 2021, vol. 675, no. 1, p. 012064. doi: <https://doi.org/10.1088/1755-1315/675/1/012064>.
2. Pandurangan R., Kaliannan P., Shanmugam P. Effects of Current Distortion on DC Link Inductor and Capacitor Lifetime in Variable Frequency Drive Connected to Grid With Active Harmonic Filter. *IEEE Transactions on Industry Applications*, 2021, vol. 57, no. 1, pp. 492-505. doi: <https://doi.org/10.1109/TIA.2020.3028555>.
3. Xiao X., Zhang Y., Wang J., Du H. An Improved Model Predictive Control Scheme for the PWM Rectifier-Inverter System Based on Power-Balancing Mechanism. *IEEE Transactions on Industrial Electronics*, 2016, vol. 63, no. 8, pp. 5197-5208. doi: <https://doi.org/10.1109/TIE.2016.2558138>.
4. Shklyarskiy J.E., Bardanov A.I. Novel Approach to Active Rectifier Control During Voltage Dips. *2018 International Multi-Conference on Industrial Engineering and Modern Technologies (FarEastCon)*, 2018, pp. 1-5. doi: <https://doi.org/10.1109/FarEastCon.2018.8602678>.
5. Krylov D., Kholod O., Radohuz S. Active rectifier with different control system types. *2020 IEEE 4th International Conference on Intelligent Energy and Power Systems (IEPS)*, 2020, pp. 273-278. doi: <https://doi.org/10.1109/IEPS51250.2020.9263226>.
6. Krylov D.S., Kholod O.I. The efficiency of the active controlled rectifier operation in the mains voltage distortion mode. *Electrical Engineering & Electromechanics*, 2021, no. 2, pp. 30-35. doi: <https://doi.org/10.20998/2074-272X.2021.2.05>.
7. Wai R.-J., Yang Y. Design of Backstepping Direct Power Control for Three-Phase PWM Rectifier. *IEEE Transactions on Industry Applications*, 2019, vol. 55, no. 3, pp. 3160-3173. doi: <https://doi.org/10.1109/TIA.2019.2893832>.
8. He H., Si T., Sun L., Liu B., Li Z. Linear Active Disturbance Rejection Control for Three-Phase Voltage-Source PWM Rectifier. *IEEE Access*, 2020, vol. 8, pp. 45050-45060. doi: <https://doi.org/10.1109/ACCESS.2020.2978579>.
9. Goncharov Y.P., Panasenko M.V. *Statychni peretvoriuvachi tiahovoho rukhomoho skladu* [Static converters of traction rolling stock]. Kharkiv, NTU «KhPI» Publ., 2007. 192 p. (Ukr).
10. *IEEE Std 519-2014. IEEE Recommended Practice and Requirements for Harmonic Control in Electric Power Systems*. 2014, 29 p. doi: <https://doi.org/10.1109/IEEESTD.2014.6826459>.
11. Bose B.K. Power semiconductor devices. In *Power Electronics and Motor Drives*, 2021, pp. 59-109. Elsevier. doi: <https://doi.org/10.1016/B978-0-12-821360-5.00002-6>.
12. Krylov D., Kholod O. The influence of the input inductance on the qualitative indicators of active controlled rectifier. *Bulletin of the National Technical University «KhPI» Series: New Solutions in Modern Technologies*, 2021, no. 1(7), pp. 18-23. doi: <https://doi.org/10.20998/2413-4295.2021.01.03>.

Received 01.01.2022

Accepted 04.04.2022

Published 20.07.2022

D.S. Krylov<sup>1</sup>, PhD, Associate Professor,

O.I. Kholod<sup>1</sup>, PhD, Senior Lecturer,

<sup>1</sup>National Technical University «Kharkiv Polytechnic Institute»,

2, Kyrpychova Str., Kharkiv, 61002, Ukraine,

e-mail: Denis.Krylov@khpi.edu.ua (Corresponding author),

Olha.Kholod@khpi.edu.ua

#### How to cite this article:

Krylov D.S., Kholod O.I. Determination of the input filter parameters of the active rectifier with a fixed modulation frequency. *Electrical Engineering & Electromechanics*, 2022, no. 4, pp. 21-26. doi: <https://doi.org/10.20998/2074-272X.2022.4.03>