

V.V. Budashko

DESIGN OF THE THREE-LEVEL MULTICRITERIAL STRATEGY OF HYBRID MARINE POWER PLANT CONTROL FOR A COMBINED PROPULSION COMPLEX

Purpose. Efficiency of hybrid ships power plants (SPP) combined propulsion complexes (CPC) by various criteria for energy management systems strategies. Methodology. Based on the classification system topologies SPP CPC for mechanical, electrical and hybrid types of motors schematic diagrams of management strategies for the criterion of minimum power consumption are defined. Changing the technical component of the traditional approach to building hybrid ships electric power systems (SEPS) SPP CPC the principle of modifying the structure of SEPS is applied with the integration of additional static alternative power source as dynamic reserve, which allowed to meet modern requirements for energy efficiency, levels of vibration, noise and degradation effects produced to SPP CPC, in all areas of the energy for the transfer of power from energy to propellers. Modeling of power transmission of energy to propellers in MatLab/Simulink is conducted, using blocks of optimization library and definition of identity markers. Results. Major advantages and disadvantages SPP CPC depending on the topology of energy distribution systems are determined. According to the chosen structure system electricity characteristics were obtained in the process of power transmission SPP CPC and power systems and their control strategies in terms of increased efficiency and eliminate these drawbacks. And finally, mathematical apparatus for research in terms of the development of methods for designing and managing SPP hybrid CPC to reduced fuel consumption, emissions into the environment and improving maintainability, flexibility and comfort level are improved. Originality. The methodology for improving SPP CPC implementation by developing methods of identification markers mutually influencing processes in SPP CPC and the development of implementing these methods of settlement and information systems. Practical value. The method enables iterative optimization parameters SPP CPC, it can be used as a means of intelligent design, which is the result of the application of improved performance SPP CPC. References 49, table 1, figures 12.

Key words: ship power plants, combined propulsion complexes, energy management system, control strategy.

На основании системной классификации топологий судовых энергетических установок (СЭУ) комбинированных пропульсивных комплексов (КПК) были систематизированы основные преимущества и недостатки СЭУ КПК в зависимости от топологии системы управления распределением энергии. Были получены характеристики процессов передачи мощности в СЭУ КПК и системах энергоснабжения, и их стратегий контроля с точки зрения повышения эффективности и устранения указанных недостатков. Усовершенствован математический аппарат для проведения исследований с точки зрения разработки методов проектирования и управления гибридными СЭУ КПК с сокращением потребления топлива, выбросов в окружающую среду и повышении ремонтпригодности, маневренности и уровня комфорта. Разработанный метод дает возможность итерационной оптимизации параметров СЭУ КПК, что позволяет использовать его как средство интеллектуального проектирования, результатом применения которого является усовершенствованные эксплуатационные характеристики СЭУ КПК. Библ. 49 табл. 1, рис. 12.

Ключевые слова: судовая энергетическая установка, комбинированный пропульсивный комплекс, система управления энергопотреблением, стратегия управления.

Introduction.

Minimizing the additional costs of changing the operating mode of ship power plant (SPP) combined propulsive complex (CPC) is achieved by providing stable power of SPP and the load of middle-rotating diesel generators (MRDG) under perturbation of the environment through optimal in terms of minimum criteria consumed power management options in the SPP CPC. In order summarized forgiveness performance SPP CPC with various of architecture-Circuit decision structures, the use of this or other intellectual management strategies based to determining the effectiveness of setting governmental regulators MRDG and frequency converters (FC) feeding rowing electric motors (REM) of under-steering device (USD) in terms of compliance with the appropriate level of specific fuel consumption (SFC) depending on the load on propellers and MRDG (Fig. 1).

Despite the diversity of structures SPP CPC they may be grouped by similar advantages and disadvantages (Table 1) analyzing what can be concluded that the main drawbacks of modern-these hybrid SPP CPC in terms of management efficiency and ensure operational modes, is

the inability to adjust MRDG speed-intensive in accordance with the load on propellers and the need for alternative sources of energy (ASE).

Problem definition. On the first stage it is necessary to categorized topology of SPP CPC by mechanical, electrical or hybrid types of engines and power topology (thermal, electrochemical and hybrid).

Then, considering the processes at SPP CPC power systems and their control strategies, increase capacity and eliminate the disadvantages of these systems and their respective controls. Finally need to develop mathematical tools for research in terms of the development of methods for designing and managing SPP CPC hybrid with reduced fuel consumption, emissions into the environment and improving maintainability, flexibility and comfort level.

Investigations are conducted under the state budget research work «Concept of technology and ways of improvement of ship power plants of combined propulsive complexes» of the National University «Odessa Maritime Academy» (state registration number 0114U/000340).

© V.V. Budashko

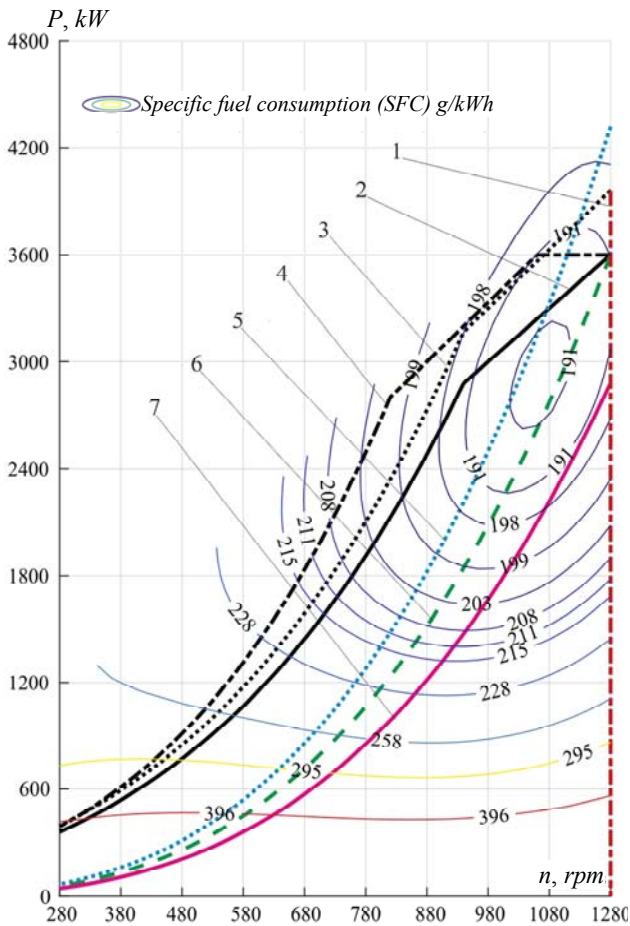

Fig. 1. Dependence of the specific fuel consumption of the load on MRDG and characteristics of propellers: 1–4 – MRDG characteristics; 1 – barrage; 2 – loading; 3 – loading with increased load rating; 4 – loading with sequential turbocharging; 5–6 – characteristics of propellers; 5 – calculated; 6 – on free water; 7 – testing

The goal of the paper is the increase of hybrid SPP CPC efficiency by combining criteria of control strategies of energy distribution.

Methods of investigations.

Hybrid SPP CPC with ASE using maximum efficiency of direct mechanical drive power and flexibility of a combination of combustion engine and the heat energy accumulated ASE is the most promising. At low power propulsive electric drive designed to bring vehicles in motion, REM provides the necessary power and excess capacity heat engine can be used as an auxiliary power supply from the shaft generator. Such SPP CPC typical architecture is shown in Fig. 2 [41, 42].

Note that MRDG equipped with automatic start-up, such as PMR (Power Management Relay) inside PMS (Power Management System) during the period of expectations are in «hot standby». This means that at least provides constant heating of the engine (for single HSPP liquid-cooled). Power station with automatic start-up can take the load after a few seconds after power failure at the main distribution board (MDB) it does not need additional time to warm the engine. In addition, there is no need to manually perform switching MDB - all necessary switching performed automatically and during MRDG carried automatic maintenance frequency output voltage and speed diesel. For particularly difficult conditions, special HSPP MRDG can work in this mode when the engine is constant, but the generator load is not connected or minimum. In this mode, fuel consumption, though not very big, but is also available. Remember that when switching to emergency mode, guaranteed job batteries. Therefore, during normal operation HSPP necessary to provide and charging batteries, in which also consumes fuel. It is clear that the total fuel consumption for the two partially loaded MRDG significantly higher than in other MRDG working under similar voltage.

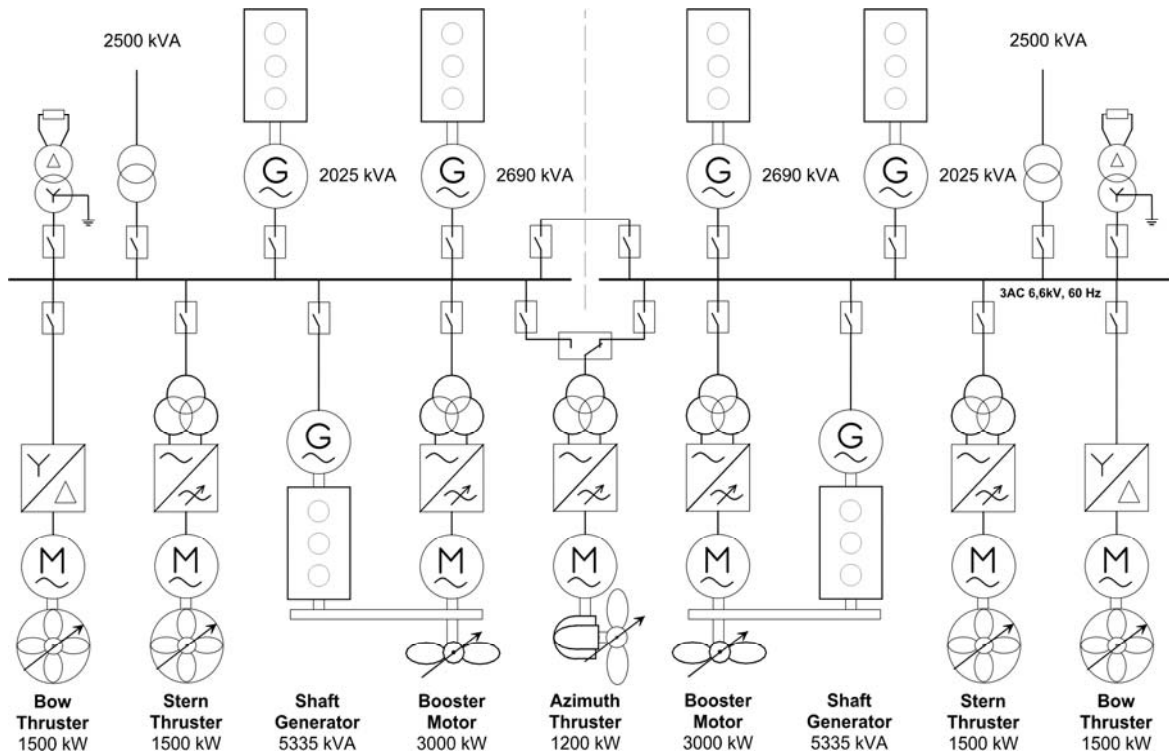

Fig. 2. One-linear circuit of the hybrid SPP CPC of the multipurpose vehicles with auxiliary USD of L-Drive type

Table 1

Advantages and disadvantages of motors and feeding systems techniques of SPP CPC

Technique	Advantages	Disadvantages	Source
Electromechanical CPC	Low power loss at the design power	Low efficiency at partial and peak loads	Fig. 1 [1, 2]
	Low CO_2 and NO_x emissions at the design power	High NO_x emission while reducing the load	[3, 4]
	Low loss of power conversion	Low reservation	[5]
		Increased noise	[6]
Diesel electrical propulsion complex (DEPC)	The overload capacity	The constancy of rotational speed of MRDG	[7, 8]
	Consistency of load with MRDG	Losses at the design power	[9, 10]
	High prospects	The risk of permanent instability of the load power	[11]
	Reduction of NO_x emission at low speed		[12]
Potentially low noise		Fig. 2 [13]	
Hybrid DEPC	Low power loss at the design power	The constancy of rotational speed of MRDG	[14]
	The overload capacity		[15, 16]
	Matching of load and REM at low-power	Difficulty of the system	[17]
	Potentially low noise of REM		[18, 19]
Hybrid DEPC with alternative sources of energy (ASE)	Independence from air quality	The limited power	[20, 21]
	Reduction of emission in air	Danger	[22]
	High efficiency and low noise	Failure to modernize	[23]
Hybrid ship electric power system (HSPP)	Independence from air quality	The limited power	[24, 25]
	Reducing of emission in air and low noise	Danger	
DEPC with HSPP	Load balancing	The constancy of rotational speed of MRDG	[26, 27]
	Zero noise and emission	Difficulty of the system	[28]
	Storing regenerated energy	The hazard of batteries maintenance	[29]
	The efficiency of backup power	Batteries cost	[30]
	Ability to pulse power ON	The need for control of each bathery	[31]
	Reduced fuel consumption and emission into the atmosphere	The possibility of failure in consequence recharging batteries	[32, 33]
	Absense of NO_x increase while increasing the load	Difficulty monitoring of batteries	Fig. 3 [34, 35]
DEPC with AC HSPP and system of energy storage (SES)	REM variable rotation speed and load	Difficulty of the system	[36]
	Optimal REM load	The cost and loss in power electronics	[37]
	Reducing noise and vibration of the motor	The increase in NO_x due to the variable power	[38]
	Reduced fuel consumption and CO_2 emission	The need for energy conservation while reducing power	[39]
	Ability to pulse power ON	Complexity control	[40]

Changing the technical component of the traditional approach to building hybrid HSPP SPP CPC suitable for use in many types of vehicles, based on the principle of modifying the structure of the HSPP many practical cases, operational modes, which work main MRDG can be carried out with loads of up to 80% of the nominal value, and dynamic reserve of energy provided from additional static ASE.

This approach is known, but its technical implementation to date has been virtually impossible because of the lack of highly static energy, which

markedly exceeds the technical and operational characteristics of classic batteries and provides a high degree of reserve and peak load electricity.

It is proposed to use in the hybrid HSPP SPP CPC additional of ASE which consists with *electric double-layer capacitor* – (EDLC).

Flowchart of classical control strategy of the hybrid SPP CPC based on the shown in Fig. 2 EDLC using the criterion of minimum power consumption is shown in Fig. 3.

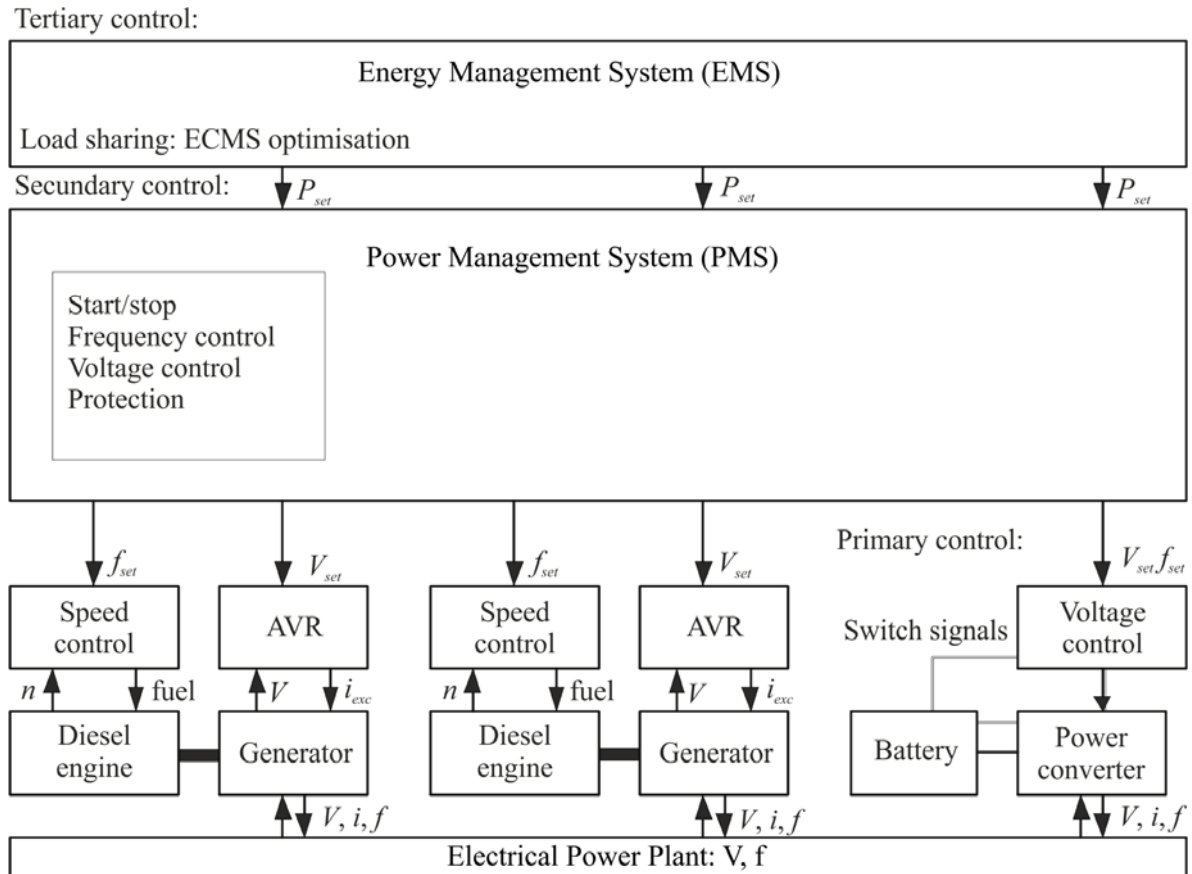

Fig. 3. Flowchart of control of hybrid SPP CPC by criterion of minimum power consumption: AVR - automatic voltage regulation; X_{set} – setpoint; P – power; f – frequency of voltage; V – voltage; n – rotational speed of MRDG; i_{exc} – generators excitation current; I – current of MRDG

The core of monitoring and control of the joint HSPP SPP CPC with EDLC as a dynamic source of power is the evaluation module of voltage EDLC and the degree of excess charge. Because the relationship between voltage and current value EDLC degree charge is approximately linear, therefore, the detection accuracy of the voltage on the capacitor will directly determine the accuracy of the information about the state of EDLC.

The energy discharge capacitor modules in the SPP CPC features disturbing forces parameterization actions are determined by the equations (1) and (2), provided of all the USD in the coordinate plane direct regulation since given by equation (3) to assess the integration of the total area all modules EDLC surface galvanic curve during discharge or charge:

$$\begin{cases} U_S(t) = I_S(t) \cdot Z_{SE} + t_{EM} \cdot \bar{v}_S(t), \\ F_S(t) = I_S(t) \cdot t_{ME} + Z_{SM} \cdot \bar{v}_S(t), \end{cases} \quad (1)$$

where Z_{SE} is the impedance of the converter from the electric side, [Ω]; Z_{SM} is the impedance of the converter from the mechanical side, [Ω]; t_{EM} is the time constant of the electromechanical transformation, [s]; t_{ME} is the time constant of the mechanical-electrical transformation, [s]

$$\begin{cases} \bar{U}_S(\mathbf{Z}) = \bar{I}_S(t) \cdot \mathbf{Z}_{SE} + t_{EM} \cdot \bar{v}_S(t), \\ \bar{F}_S(\mathbf{Z}) = \bar{I}_S(t) \cdot t_{ME} + \mathbf{Z}_{SM} \cdot \bar{v}_S(t), \\ (m_{cS} + m_{ncS}) \cdot \frac{d\bar{v}_S(t)}{dt} + \mu_S \bar{v}_S(t) + \mu_R \int_{\varepsilon_0}^{\varepsilon} \bar{v}_S(t) dt = \bar{F}_S(\mathbf{Z}), \end{cases} \quad (2)$$

where $F_S(\mathbf{Z}) = (F_{S1}(\mathbf{Z}^1), F_{S2}(\mathbf{Z}^2), F_{S3}(\mathbf{Z}^3), F_{S4}(\mathbf{Z}^4), \dots, F_{Si}(\mathbf{Z}^m))^{T_{matrix(i)}}$; complex impedance is defined by

matrices of active and inductive components of the equivalent circuit complex load $Z^m = R^m + pjL^m$; $T_{matrix(i)}$ is the thruster matrix of configuration parameters of devices, where $(i = 0 \dots k)$ is the number of the corresponding configuration regarding Table 1 and selected technique of the SPP CPC [43, 44].

$$E_{int/SOC}(t) = I_{EDLC} \int_{U_{EDLC_min}}^{U_{EDLC_max}} U_S(t) dt \quad (3)$$

Equation (3) permits to calculate the power charger needed to ensure the required level of charge $EDLC$ for a particular operating mode SPP CPC during dynamic loading. Whence all capacity capacitor modules will be determined by the formula:

$$C_{int/EDLC} = \frac{2E_{int/SOC}}{(U_{EDLC_max})^2} \quad (4)$$

Power capacitors of $EDLC$ of hybrid DEPC are formed in the modules by determining the necessary energy charge/discharge capacity calculated in chargers. Considering the large number of power devices, high-voltage and high-power lines between modules and HSPP SPP CPC, electromagnetic environment is complicated. The program operation monitoring system should consist of two parts: a control system (CS) and integrated control unit monitoring capacity. The integrated control unit will

be responsible for tracking and signal processing modules of $EDLC$, for example, the total capacity voltage level of the charging and discharge currents about ambient temperature and so on. CS will monitor algorithms and data storage in $EDLC$ modules, system status monitoring and control, power management devices and schemes of the man-machine interface.

To exchange information in various control devices as a communication center in SPP CPC it is planned to use the *network* in order to send commands to the monitoring unit of $EDLC$ modules on the system bus and receive data downloads. Each unit monitoring modules $EDLC$ responsible for: receiving a signal state of one $EDLC$ by voltage and temperature.

To select the number and capacity of $EDLC$ according to the type and characteristics of SPP CPC operating mode at the start according to the components of complex impedance matrix parameters determine the active and inductive components integrated load equivalent circuit $Z^m = R^m + pjL^m$ (Fig. 4). And for the value of the stop mode direct control point forward coefficients matrix configuration parameters of thruster devices $T_{matrix(i)}$, where $(i = 0 \dots k)$ is the number of the configuration.

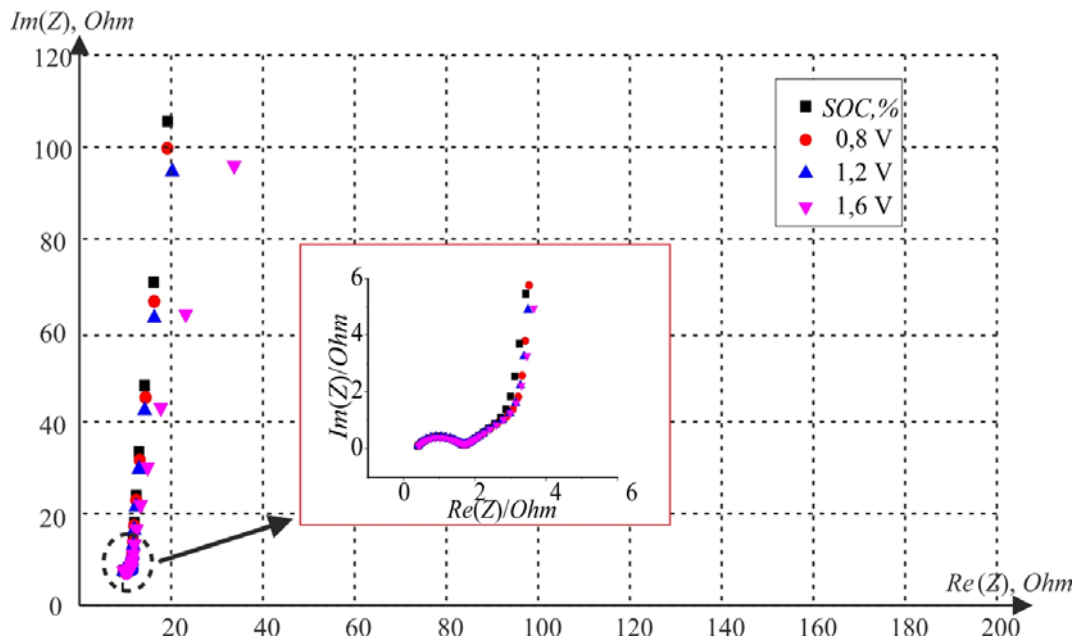

Fig. 4. Parameters for determining integrated load of capacitance of $EDLC$ for a particular operating mode of the SPP CPC: the degree of charge of $EDLC$ (State-of-Charge – SOC)

For example, for the circuit of the SPP CPC (Fig. 2) [45, 46] on the ship are two main classic screw the left and right sides of the stern of the ship; two feed tunnel USD; one azimuthal USD that slides out from the hull in the bow of the vessel, which can be rotated to any angle α_A (Fig. 8) relative to centreline of the ship; two bow tunnel USD ($u_{T1,2}$ – the main focuses of classic screws; $u_{T3,4}$ – the focuses of feeding tunnel USD; u_{T5} – focus of support azimuth USD, $u_{T6,7}$ – the focuses of nasal USD):

$$T_{matrix} = \begin{pmatrix} 1 & 1 & 0 & 0 & \cos\alpha_{A5} & 0 & 0 \\ 0 & 0 & 1 & 1 & \sin\alpha_{A5} & 1 & 1 \\ l_{T1} & -l_{T2} & -l_{T3} & -l_{T4} & l_{T5}\sin\alpha_{A5} & l_{T6} & l_{T7} \end{pmatrix}, (5)$$

where l_{Ti} ($i = 1 \dots 7$) is the arm strength or distance from the application of USD to focus this effort τ_T vector projection onto the plane of the ship.

Then, according to the type of $EDLC$ we calculate frequency response (FR) (Fig. 5) and the initial parameters of the charge/discharge of the prescribed limits of SOC (Fig. 6).

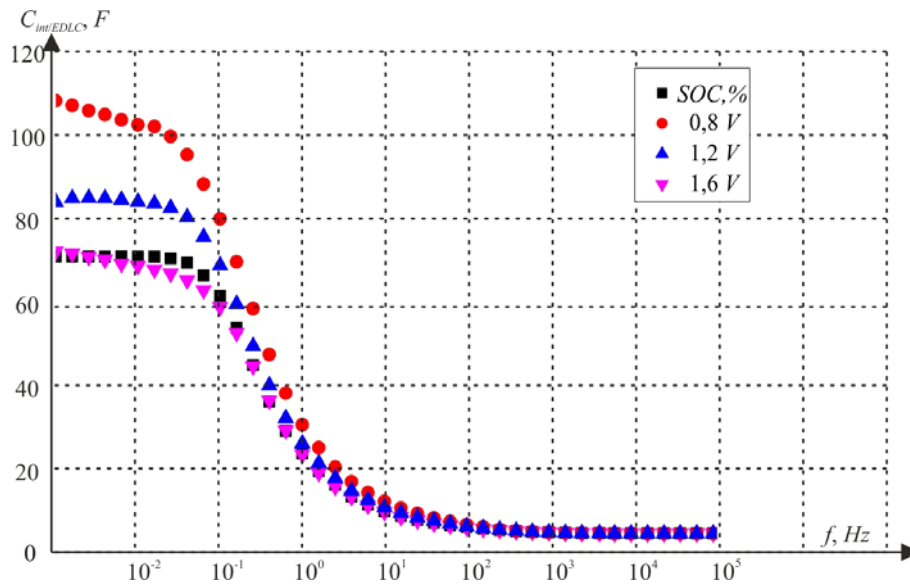

Fig. 5. Frequency response of the selected EDLC

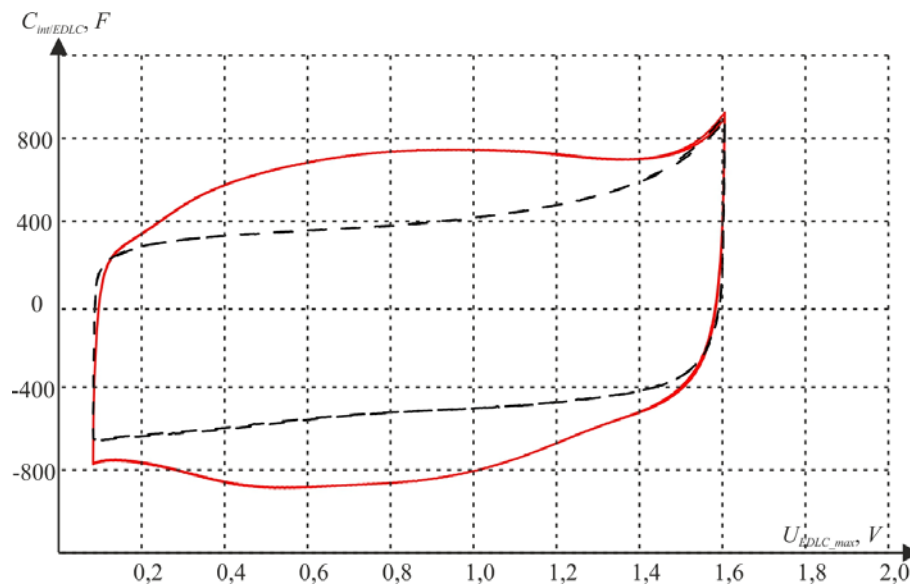

Fig. 6. Charge/discharge parameters of the selected EDLC in the prescribed limits of SOC

And, finally, the calculated effectiveness of the proposed configuration of SPP CPC handheld dynamic type EDLC power supply for a particular operating mode (Fig. 7), taking into account situational factors set of the operating mode SPP CPC of the particular ship, single-line diagram of which is presented in Fig. 2. These factors are taken into account in the task of solving local problems identifying operational mode, each of which corresponds to a composition of effective variables [47, 48].

Results of investigations. Based on the proposed method we improved the control strategy of SPP CPC by criterion of minimum power consumption by introducing criterion for maximum alternative energy and regulating the degree battery of SES using ASE to minimize fuel consumption.

Compliance with other criteria such as noise, vibration, emission into the environment or maintenance of MRDG (see Table 1) is primarily dependent on the

operating point of MRDG (Fig. 1) and ASE (Fig. 7) and is determined by adjusting the control system of distribution electricity (Fig. 3).

Thus, similar to the cost function depending on the mode of MRDG can be obtained on these criteria, as well as the overall optimal power of SPP CPC can be determined from the weighted cost function on several criteria.

Improvement strategies criterion for obtaining the maximum alternative energy and regulating the degree battery of SES using ASE is a promising approach to improve SPP CPC compared with many features for future developments [49].

Ultimately, further research must move by combining management strategies in terms of integrated approach. Block diagram of one embodiment of improved management strategies integrated system with hybrid DEPC and joint HSPP is shown in Fig. 8.

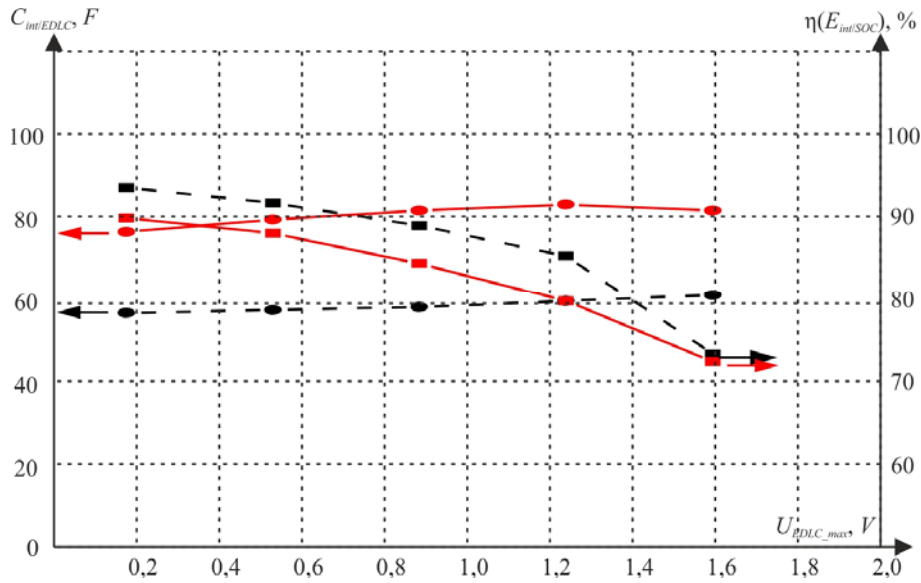

Fig. 7. Comparative characteristics of effective charge/discharge cycles of EDLC for proposed configuration of SPP CPC dynamic sources of power for two operating modes: fully equipped – 4 MRDG (red solid line); partially equipped – 3 MRDG (black dotted line)

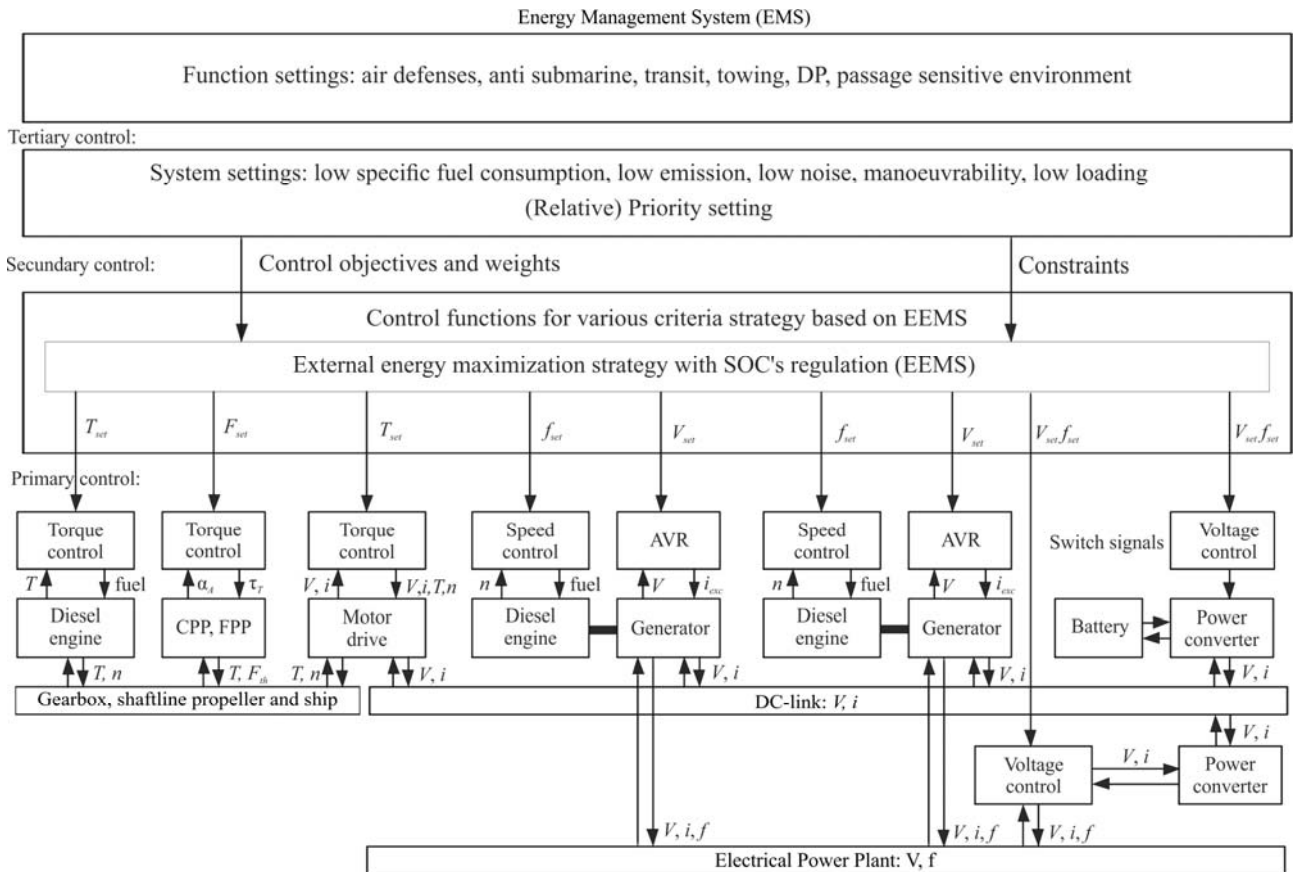

Fig. 8. Block diagram of the control strategy of SPP CPC by criterion of maximum regulation and alternative energy of the battery charge of the SES: AVR – automatic voltage regulation; VPP – variable pitch propeller; FPP – fixed pitch propeller; X_{set} – setpoint; T – focus (torque); F – force of push the propeller; f – frequency of voltage; V – voltage; n – rotational speed of MRDG; i_{exc} – generators excitation current; i – current; τ_T – resulting force vector projection onto the plane of the ship; α_A – angle of rotation relative to ship centreline

Fig. 9 - 12 show obtained dependences of modeling processes in hybrid power transmission DEPC. Simulations are conducted in *MatLab/Simulink*. Since the beginning of the transient ($t = 0$ s), the load is powered

from the main MRDG. SES of the hybrid DEPC plug for charging batteries and is preparing for a possible breakdown of the ship.

On the 40th second the vessel is de-energized and the system of power switches with power MRDG on ASE. This request exceeds capacity provided by the DC

link, which implemented energy recovery from consumers, working in generator mode, as EDLC power increases slowly.

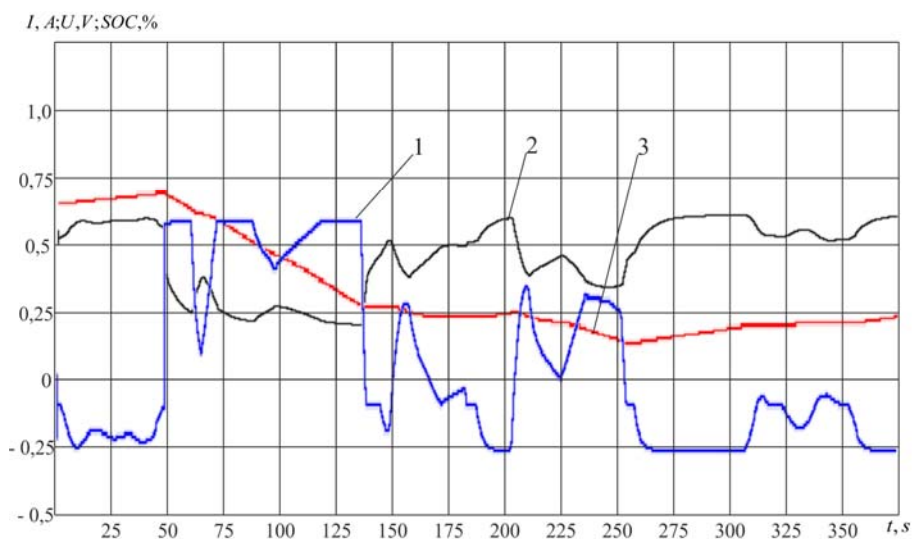

Fig. 9. Energy characteristics of SES: 1 – maximum current value corresponding to 400 A; 2 – maximum voltage value corresponding to 48 V; 3 – maximum level of charge corresponds to 100%

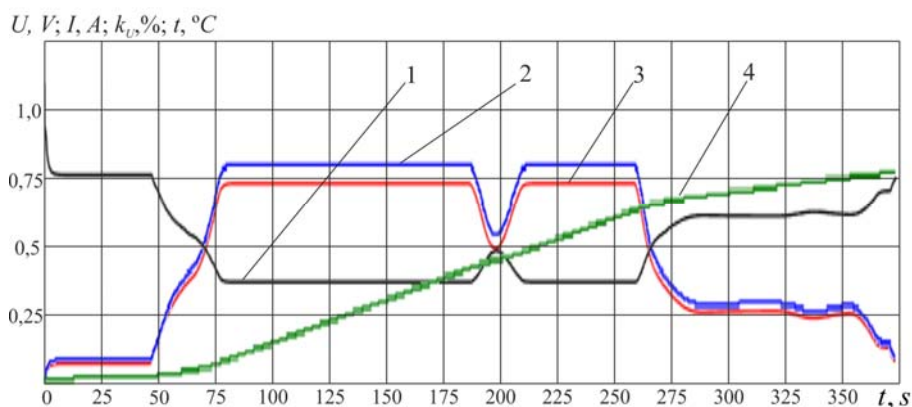

Fig. 10. Energy characteristics of EDLC: 1 – maximum voltage value corresponds to 180 V; 2 – maximum current value corresponds to 270 A; 3 – the maximum voltage in relation to the EDLC circuit voltage corresponding to value of 1; 4 – maximum temperature of EDLC corresponds to value of 50 °C

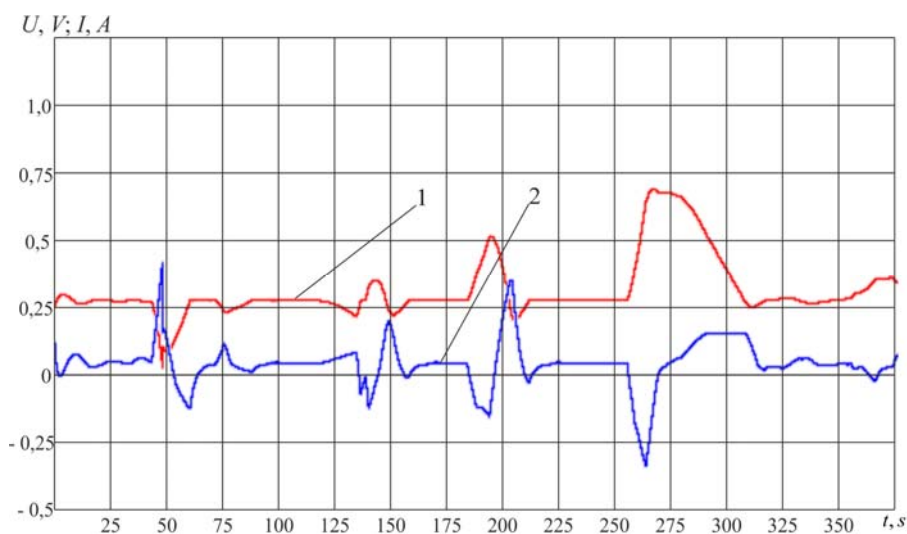

Fig. 11. Dependencies of voltage and current in the DC link: 1 – maximum voltage value corresponds to 450 V; 2 – maximum current value corresponds to 1150 A

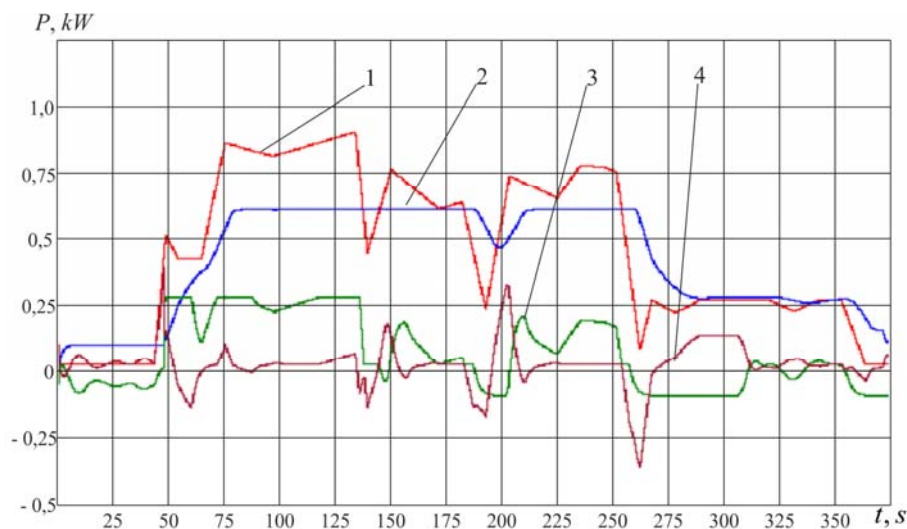

Fig. 12. Energy characteristics of hybrid DEPC: 1 – maximum power load value corresponds to 1000 kW; 2 – maximum power on SES corresponds to 10 kW; 3 – maximum power on SES corresponds to 20 kW; 4 – maximum power for DC-Link corresponds to the value of 300 kW

At $t = 45$ s the voltage on the DC link has reached the lowest level (280 V) and SES is connected to its bus and feeds up to 450 V, the voltage at which on the 47th second increases to the required level and Sneh limits the capacity gradually to zero. EDLC provides the necessary power their needs and continue to fuel the bus DC link, which connected on the 55th second customers operating in emergency mode. On the 62nd second SES is turned on supporting bus voltage DC to 450 V to help EDLC to provide additional load power loading.

After the 80th seconds the power of EDLC reaches the maximum value that the set point is limited to 10 kW maximum output voltage of the converter DC/AC. Therefore, the required power load their needs provided Sneh, whose maximum power is reached at $t = 120$ s (20 kW) and load power is provided via the bus of the DC link.

On the 130th second request of power load is reduced below capacity on which EDLC designed. Due to the fact that EDLC low inherent dynamic characteristics during transient additional power consumers is switched to the DC link.

The results of investigations of processes of power transmission in hybrid SPP CPC give reason to believe that the solution of the problem of increase of efficiency of last ones is possible by combining the classic control strategy of power distribution with strategy to control the degree of charge of alternative power sources. The set of proposed strategies allows to design flexible multipurpose electric power systems that are integrated into hybrid SPP CPC as an integral component.

Taking into account that the degree of adjustment of charge of EDLC is insignificant in relation to the consumption of reactive power, and voltage and power converters with low harmonic creates a problem of recovery of electric power we can say that reactive power compensation occurs mainly due to the transfer of MRDG to the compensator mode by corresponding adjustment of PID compensators regulators.

Conclusions. In the paper a scientific and applied problem of SPP CPC improvement by developing an

integrated three-level multicriterial control strategy of energy distribution is solved.

The proposed method meets the modern requirements for energy efficiency, levels of vibration, noise and degradation effects imposed on the SPP CPC in all areas of the energy process of the transfer of power from energy to propellers. This allows parameterization of propulsive and power characteristics of SPP CPC depending on changes in operating modes, hydrodynamic characteristics and environmental conditions.

What is important is the possibility of iterative optimization of SPP CPC parameters that allows to use the method developed as a means of intelligent design which results in enhanced performance of SPP CPC.

REFERENCES

1. Geertsma R.D., Negenborn R.R., Visser K., Hopm J.J. Design and control of hybrid power and propulsion systems for smart ships: A review of developments. *Applied Energy*, 2017, v.194, pp. 30-54. doi: 10.1016/j.apenergy.2017.02.060.
2. Kim D.H., Paik J.K. Ultimate limit state-based multi-objective optimum design technology for hull structural scantlings of merchant cargo ships. *Ocean Engineering*, 2017, v.129, pp. 318-334. doi: 10.1016/j.oceaneng.2016.11.033.
3. Gonca G., Sahin B., Parlak A., Ust Y., Ayhan V., Cesur İ., Boru B. Theoretical and experimental investigation of the Miller cycle diesel engine in terms of performance and emission parameters. *Applied Energy*, 2015, v.138, pp. 11-20. doi: 10.1016/j.apenergy.2014.10.043.
4. Ko J., Jin D., Jang W., Myung C.-L., Kwon S., Park S. Comparative investigation of NOx emission characteristics from a Euro 6-compliant diesel passenger car over the NEDC and WLTC at various ambient temperatures. *Applied Energy*, 2017, v.187, pp. 652-662. doi: 10.1016/j.apenergy.2016.11.105.
5. Baldi F., Johnson H., Gabriellii C., Andersson K. Energy Analysis of Ship Energy Systems – The Case of a Chemical Tanker. *Energy Procedia*, 2014, v.61, pp. 1732-1735. doi: 10.1016/j.egypro.2014.12.200.
6. Vrijdag A., Stapersma D., van Terwisga T. Control of propeller cavitation in operational conditions. *Journal of Marine Engineering & Technology*, 2010, v.9, pp. 15-26. doi: 10.1080/20464177.2010.11020228.
7. Natale F.D., Carotenuto C. Particulate matter in marine diesel engines exhausts: Emissions and control strategies.

- Transportation Research Part D: Transport and Environment*, 2015, v.40, pp. 166-191. doi: **10.1016/j.trd.2015.08.011**.
8. Zhao F., Yang W., Tan W.W., Yu W., Yang J., Chou S.K. Power management of vessel propulsion system for thrust efficiency and emissions mitigation. *Applied Energy*, 2016, v.161, pp. 124-132. doi: **10.1016/j.apenergy.2015.10.022**.
9. Bassam A.M., Phillips A.B., Turnock S.R., Wilson P.A. An improved energy management strategy for a hybrid fuel cell/battery passenger vessel. *International Journal of Hydrogen Energy*, 2016, v.41, iss.47, pp. 22453-22464. doi: **10.1016/j.ijhydene.2016.08.049**.
10. Symington W.P., Belle A., Nguyen H.D., Binns J.R. Emerging technologies in marine electric propulsion. *Proceedings of the Institution of Mechanical Engineers, Part M: Journal of Engineering for the Maritime Environment*, 2014, v.230, iss.1, pp. 187-198. doi: **10.1177/1475090214558470**.
11. Kwatny H.G., Bajpai G., Miu K., Yasar M. Fuel Optimal Control With Service Reliability Constraints for Ship Power Systems. *IFAC Proceedings Volumes*, 2014, v.47, iss.3, pp. 6386-6391. doi: **10.3182/20140824-6-ZA-1003.01773**.
12. Chuang S.-J., Hong C.-M., Chen C.-H. Improvement of integrated transmission line transfer index for power system voltage stability. *International Journal of Electrical Power & Energy Systems*, 2016, v.78, pp. 830-836. doi: **10.1016/j.ijepes.2015.11.111**.
13. Vernengo G., Gaggero T., Rizzuto E. Simulation based design of a fleet of ships under power and capacity variations. *Applied Ocean Research*, 2016, v.61, pp. 1-15. doi: **10.1016/j.apor.2016.09.003**.
14. Lützen M., Mikkelsen L.L., Jensen S., Rasmussen H.B. Energy efficiency of working vessels – A framework. *Journal of Cleaner Production*, 2017, v.143, pp. 90-99. doi: **10.1016/j.jclepro.2016.12.146**.
15. McCoy T.J. Trends in ship electric propulsion. *IEEE Power Engineering Society Summer Meeting*, 2002, v.1, pp. 243-346. doi: **10.1109/PSS.2002.1043247**.
16. Zivi E. Design of robust shipboard power automation systems. *Annual Reviews in Control*, 2005, v.29, iss.2, pp. 261-272. doi: **10.1016/j.arcontrol.2005.08.004**.
17. Castles G., Reed G., Bendre A., Pitsch R. Economic benefits of hybrid drive propulsion for naval ships. *IEEE Electric Ship Technologies Symposium*, 2009. doi: **10.1109/ESTS.2009.4906560**.
18. Baldi F., Ahlgren F., Melino F., Gabrielli C., Andersson K. Optimal load allocation of complex ship power plants. *Energy Conversion and Management*, 2016, v.124, pp. 344-356. doi: **10.1016/j.enconman.2016.07.009**.
19. Sulligoi G., Castellani S., Aizza M., Bosich D., Piva L., Lipardi G. Active front-end for shaft power generation and voltage control in FREMM frigates integrated power system: Modeling and validation. *International Symposium on Power Electronics Power Electronics, Electrical Drives, Automation and Motion*, 2012, pp. 452-457. doi: **10.1109/SPEEDAM.2012.6264570**.
20. Bigdeli N. Optimal management of hybrid PV/fuel cell/battery power system: a comparison of optimal hybrid approaches. *Renewable and Sustainable Energy Reviews*, 2015, v.42, pp. 377-393. doi: **10.1016/j.rser.2014.10.032**.
21. Choi C.H., Yu S., Han I.-S., Kho B.-K., Kang D.-G., Lee H.Y., Seo M.-S., Kong J.-W., Kim G., Ahn J.-W., Park S.-K., Jang D.-W., Lee J.H., Kim M. Development and demonstration of PEM fuel-cell-battery hybrid system for propulsion of tourist boat. *International Journal of Hydrogen Energy*, 2016, v.41, iss.5, pp. 3591-3599. doi: **10.1016/j.ijhydene.2015.12.186**.
22. José J. de-Troya, Álvarez C., Fernández-Garrido C., Carral L. Analysing the possibilities of using fuel cells in ships. *International Journal of Hydrogen Energy*, 2016, v.41, iss.4, pp. 2853-2866. doi: **10.1016/j.ijhydene.2015.11.145**.
23. Nelson D.B., Nehrir M.H., Wang C. Unit sizing and cost analysis of stand-alone hybrid wind/PV/fuel cell power generation systems. *Renewable Energy*, 2006, v.31, iss.10, pp. 1641-1656. doi: **10.1016/j.renene.2005.08.031**.
24. Ramli M., Hiendro A., Twaha S. Economic analysis of PV/diesel hybrid system with flywheel energy storage. *Renewable Energy*, 2015, v.78, pp. 398-405. doi: **10.1016/j.renene.2015.01.026**.
25. Rezzouk H., Mellit A. Feasibility study and sensitivity analysis of a stand-alone photovoltaic-diesel-battery hybrid energy system in the north of Algeria. *Renewable and Sustainable Energy Reviews*, 2015, v.43, pp. 1134-1150. doi: **10.1016/j.rser.2014.11.103**.
26. Vetter M., Lux S. Rechargeable Batteries with Special Reference to Lithium-Ion Batteries. *Storing Energy*, 2016, pp. 205-225. doi: **10.1016/B978-0-12-803440-8.00011-7**.
27. Zahedi B., Norum L.E., Ludvigsen K.B. Optimized efficiency of all-electric ships by DC hybrid power systems. *Journal of Power Sources*, 2014, v.255, pp. 341-354. doi: **10.1016/j.jpowsour.2014.01.031**.
28. Wang L., Lee D.J., Lee W.J., Chen Z. Analysis of a novel autonomous marine hybrid power generation/energy storage system with a high-voltage direct current link. *Journal of Power Sources*, 2008, v.185, iss.2, pp. 1284-1292. doi: **10.1016/j.jpowsour.2008.08.037**.
29. Ovrum E., Bergh T.F. Modelling lithium-ion battery hybrid ship crane operation. *Applied Energy*, 2015, v.152, pp. 162-172. doi: **10.1016/j.apenergy.2015.01.066**.
30. Haseltalab A., Negenborn R.R., Lodewijks G. Multi-Level Predictive Control for Energy Management of Hybrid Ships in the Presence of Uncertainty and Environmental Disturbances. *IFAC-Papers On Line*, 2016, v.49, iss.3, pp. 90-95. doi: **10.1016/j.ifacol.2016.07.016**.
31. Lashway C.R., Elsayed A.T., Mohammed O.A. Hybrid energy storage management in ship power systems with multiple pulsed loads. *Electric Power Systems Research*, 2016, v.141, pp. 50-62. doi: **10.1016/j.epsr.2016.06.031**.
32. Giannoutsos S.V., Manias S.N. Energy management and D/G fuel consumption optimization in the power system of marine vessels through VFD-based process flow control. *IEEE 15th International Conference on Environment and Electrical Engineering (EEEIC)*, 2015, pp. 842-850. doi: **10.1109/EEEIC.2015.7165274**.
33. Zhao F., Yang W., Tan W.W., Yu W., Yang J., Chou S.K. Power management of vessel propulsion system for thrust efficiency and emissions mitigation. *Applied Energy*, 2016, v.161, pp. 124-132. doi: **10.1016/j.apenergy.2015.10.022**.
34. Papalambrou G., Karlis E., Kyrtatos N. Robust Control of Manifold Air Injection in a Marine Diesel Engine. *IFAC-Papers On Line*, 2015, v.48, iss.14, pp. 438-443. doi: **10.1016/j.ifacol.2015.09.496**.
35. Papalambrou G., Kyrtatos N. Controlled Injection of Compressed Air in Marine Diesel Engine Intake for Improved Load Acceptance. *IFAC Proceedings Volumes*, 2009, v.42, iss.26, pp. 140-147. doi: **10.3182/20091130-3-FR-4008.00019**.
36. Shih N.-C., Weng B.-J., Lee J.-Y., Hsiao Y.-C. Development of a 20kW generic hybrid fuel cell power system for small ships and underwater vehicles. *International Journal of Hydrogen Energy*, 2014, v.39, iss.25, pp. 13894-13901. doi: **10.1016/j.ijhydene.2014.01.113**.
37. Zhang S., Xiong R., Sun F. Model predictive control for power management in a plug-in hybrid electric vehicle with a hybrid energy storage system. *Applied Energy*, 2017, v.185, pp. 1654-1662. doi: **10.1016/j.apenergy.2015.12.035**.
38. Butcher M., Maltby R., Parvin P.S. Compact DC power and propulsion systems – the definitive solution? *IEEE Electric Ship Technologies Symposium*, 2009, pp. 521-528. doi: **10.1109/ESTS.2009.4906561**.

39. Hodge C.G., Mattick D.J. The electric warship then, now and later. *Proceedings of the 9th international naval engineering conference*, 2008, pp. 556-565.
40. Indragandhi V., Subramaniaswamy V., Logesh R. Resources, configurations, and soft computing techniques for power management and control of PV/wind hybrid system. *Renewable and Sustainable Energy Reviews*, 2017, v.69, pp. 129-143. doi: **10.1016/j.rser.2016.11.209**.
41. Budashko V., Nikolskyi V., Onishchenko O., Khniunin S. Physical model of degradation effect by interaction azimuthal flow with hull of ship. *Proceeding Book of International Conference on Engine Room Simulators (ICERS12)*. Istanbul: Istanbul Technical University, Maritime Faculty, 2015. pp. 49-53. ISBN 978-605-01-0782-1.
42. Nikolskyi V., Budashko V., Khniunin S. The monitoring system of the Coanda effect for the tension-leg platform's. *Proceeding Book of International Conference on Engine Room Simulators (ICERS12)*. Istanbul: Istanbul Technical University, Maritime Faculty, 2015. pp. 45-49. ISBN 978-605-01-0782-1.
43. Budashko V.V., Onishchenko O.A. Improving management system combined thruster propulsion systems. *Bulletin of NTU «KhPI»*, 2014, no.38(1081), pp. 45-51. (Ukr).
44. Budashko V.V. Implementation approaches during simulation of energy processes for a dynamically positioned ship. *Electrical Engineering & Electromechanics*, 2015, no.6, pp. 14-19. doi: **10.20998/2074-272X.2015.6.02**. (Rus).
45. Budashko V.V., Onishchenko O.A., Yushkov E.A. Physical modeling of multi-propulsion complex. *Collection of scientific works of the Military Academy (Odessa City)*, 2014, no.2, pp. 88-92. (Rus).
46. Budashko V.V., Nikolskyi V.V., Khniunin S.H. *Sudova systema monitorynhu dlya poperedzhennya efektu Koanda* [Ship monitoring system for the prevention of Coanda effect]. Patent UA, no.100819, 2015. (Ukr).
47. Budashko V.V., Yushkov E.A. *Systema impulsno-fazovoho upravlinnya elektropryvodom sudnovoyi hvynto-kermovoyi ustanovky* [The pulse-phase control system of electric ship propeller-steering plant]. Patent UA, no.108074, 2016. (Ukr).
48. Khniunin S.H., Budashko V.V., Nikolskyi V.V. *Sudova systema monitorynhu dlya poperedzhennya efektu Koanda* [Ship system for monitoring for preventing the Coanda effect]. Patent UA, no.107006, 2016. (Ukr).
49. Budashko V., Nikolskyi V., Onishchenko O., Khniunin S. Decision support system's concept for design of combined propulsion complexes. *Eastern-European Journal of Enterprise Technologies*, 2016, v.3, no.8(81), pp. 10-21. doi: **10.15587/1729-4061.2016.72543**.

Received 24.03.2017

V.V. Budashko, Candidate of Technical Science, Associate Professor,
Odessa National Maritime Academy,
8, Didrikhson Str., Odessa, 65029,
phone +380 48 7332367,
e-mail: bvv@te.net.ua

How to cite this article:

Budashko V.V. Design of the three-level multicriterial strategy of hybrid marine power plant control for a combined propulsion complex. *Electrical engineering & electromechanics*, 2017, no.2, pp. 62-72. doi: **10.20998/2074-272X.2017.2.10**.